

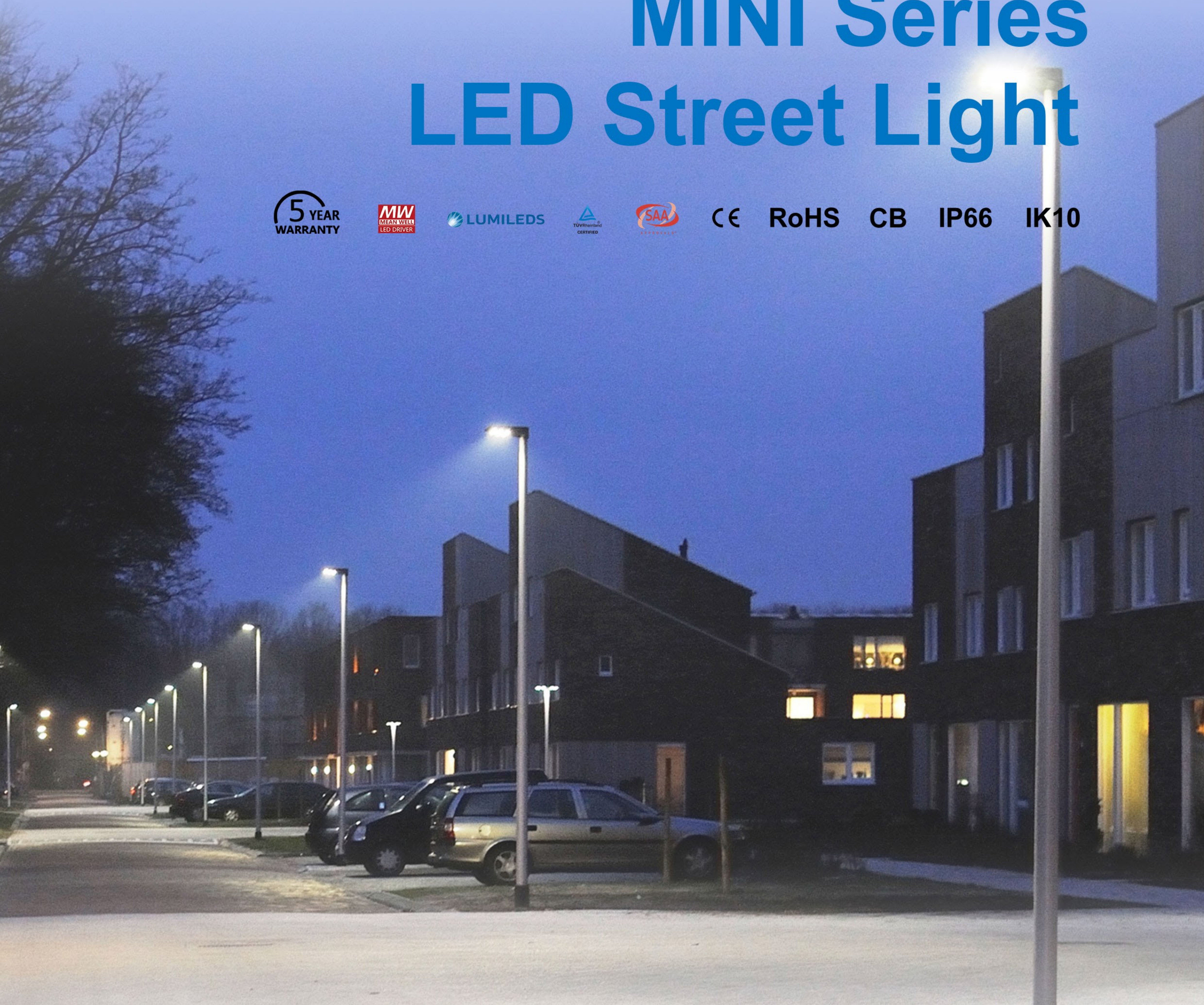

MINI Series LED Street Light

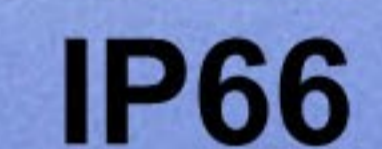

Function & Features



Tool free & Page Design

Page design for tool-free maintenance.....

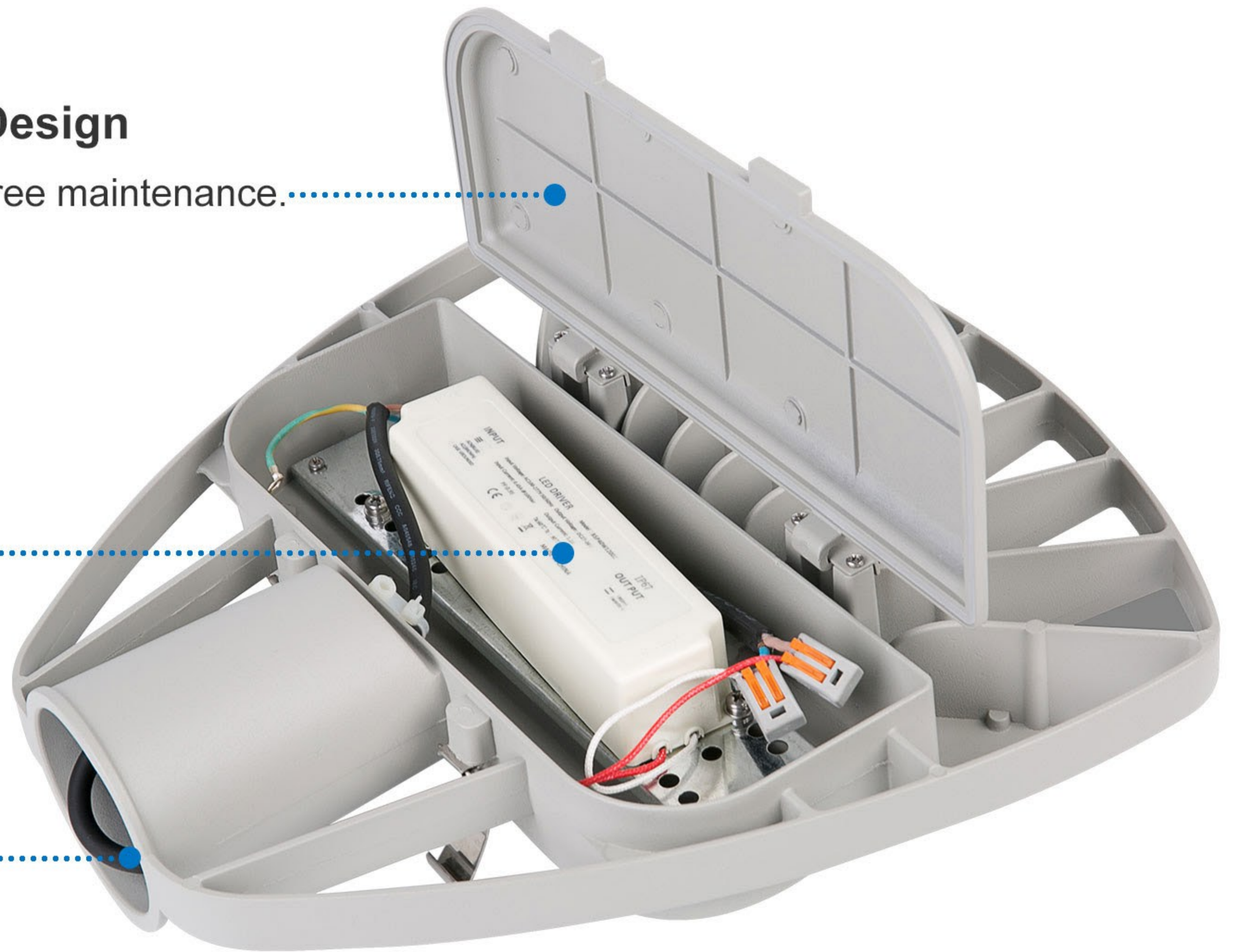

Branded LED Driver

Can achieve intelligent lighting control and 6KV/10KV surge protection. Providing excellent performance and lifespan.

Pole Adaptor.....



Optical Lens

Imported optical lens with high lighting transmittance, anti-UV materials, secondary light dissipation technology.



*40-60mm pole diameter fitted.

*Stainless steel screws for whole luminaire, no corrosion worries.

Technical Parameters

Model No.	BSL30Z-F14X	BSL40Z-F14X	BSL50Z-F14X	BSL60Z-F14X	BSL70Z-F14X	BSL80Z-F14X
Nominal Wattage	30W	40W	50W	60W	70W	80W
Input Voltage	AC100~305V 50/60Hz or DC12/24V (with controller)					
Power Factor	>0.95					
T.H.D	<20%					
C.R.I	75±5					
C.C.T	3000K / 4000K / 5000K / 5700K / 6500K					
Life Span	>50000Hours					
Luminaire Efficacy	>120lm/W(3030 LEDs) / >150lm/W(5050LEDs)					
Heat Radiator	Anodized Aluminum					
Fixture Material	Die-casting Aluminum + PC					
Rating	IP66 , IK10					
Pole Mounting Diameter	Suitable for ϕ 40-60mm Pole					
Warranty	5 Years					
	Thermal conductivity of PCB board >2.0					

Install Height

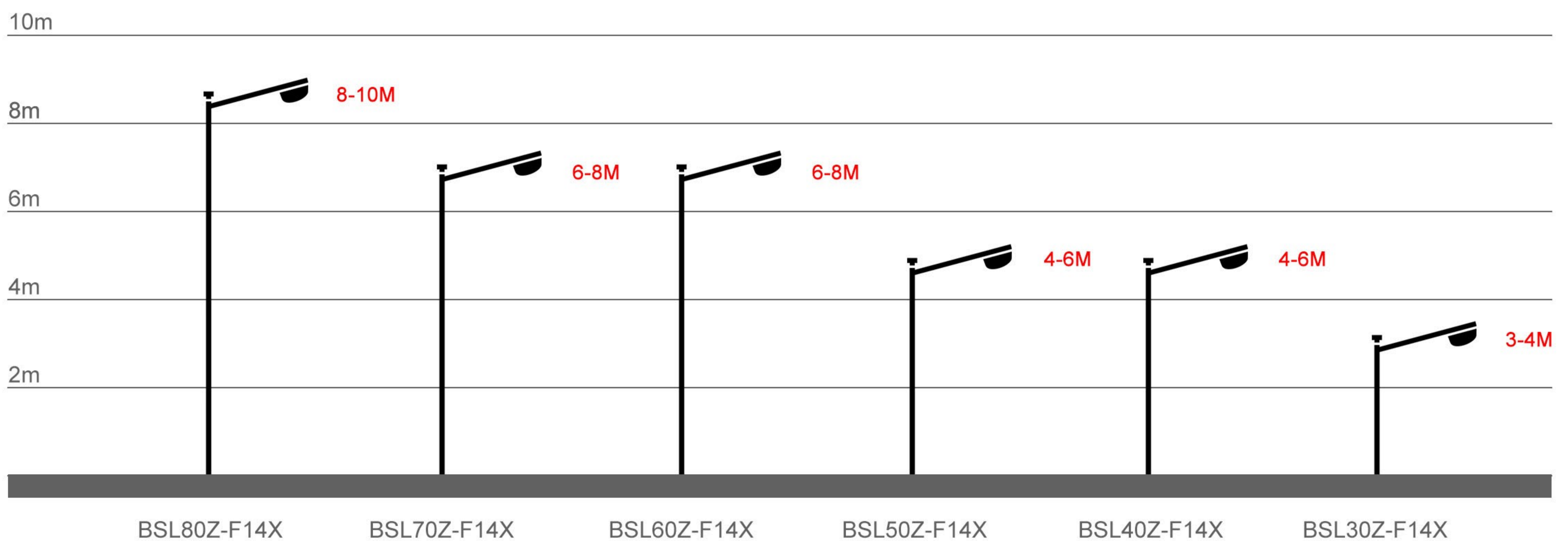

Distribution Curve

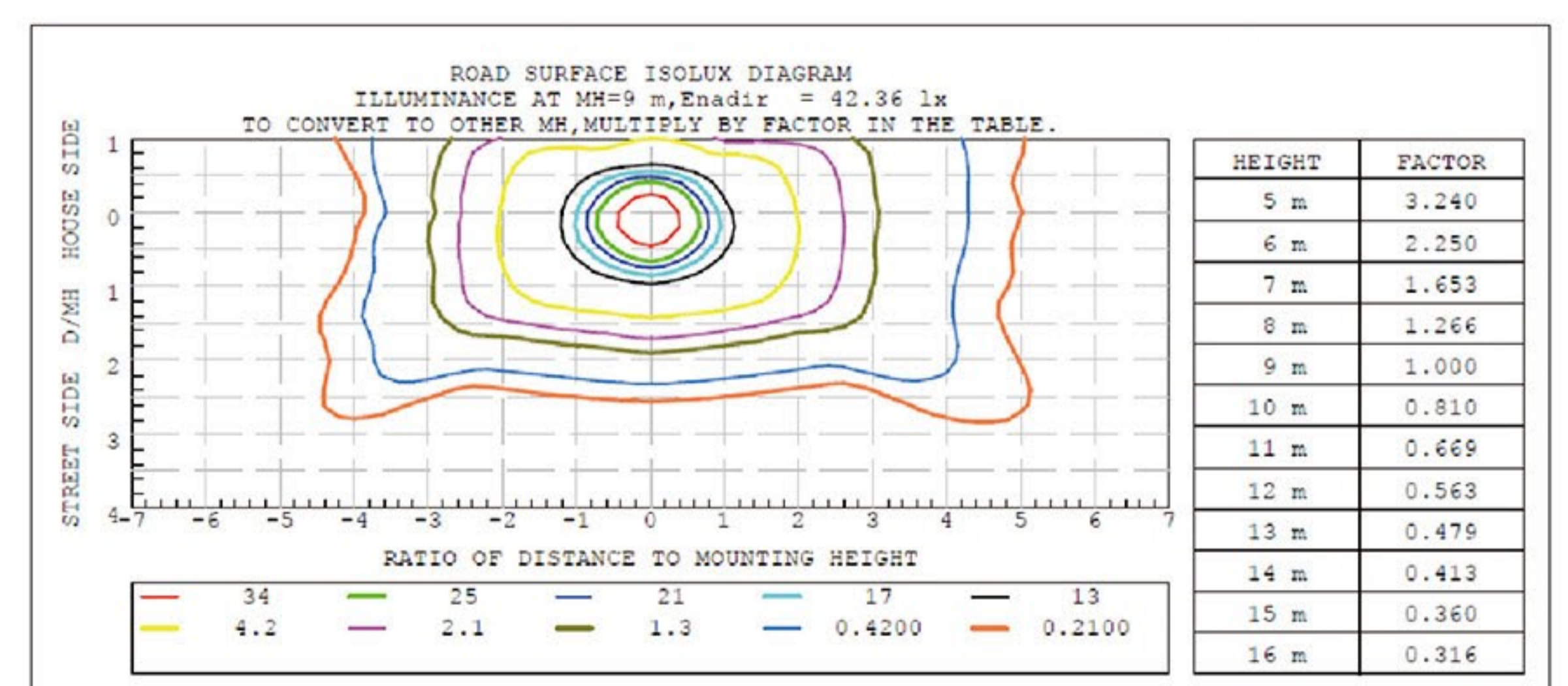
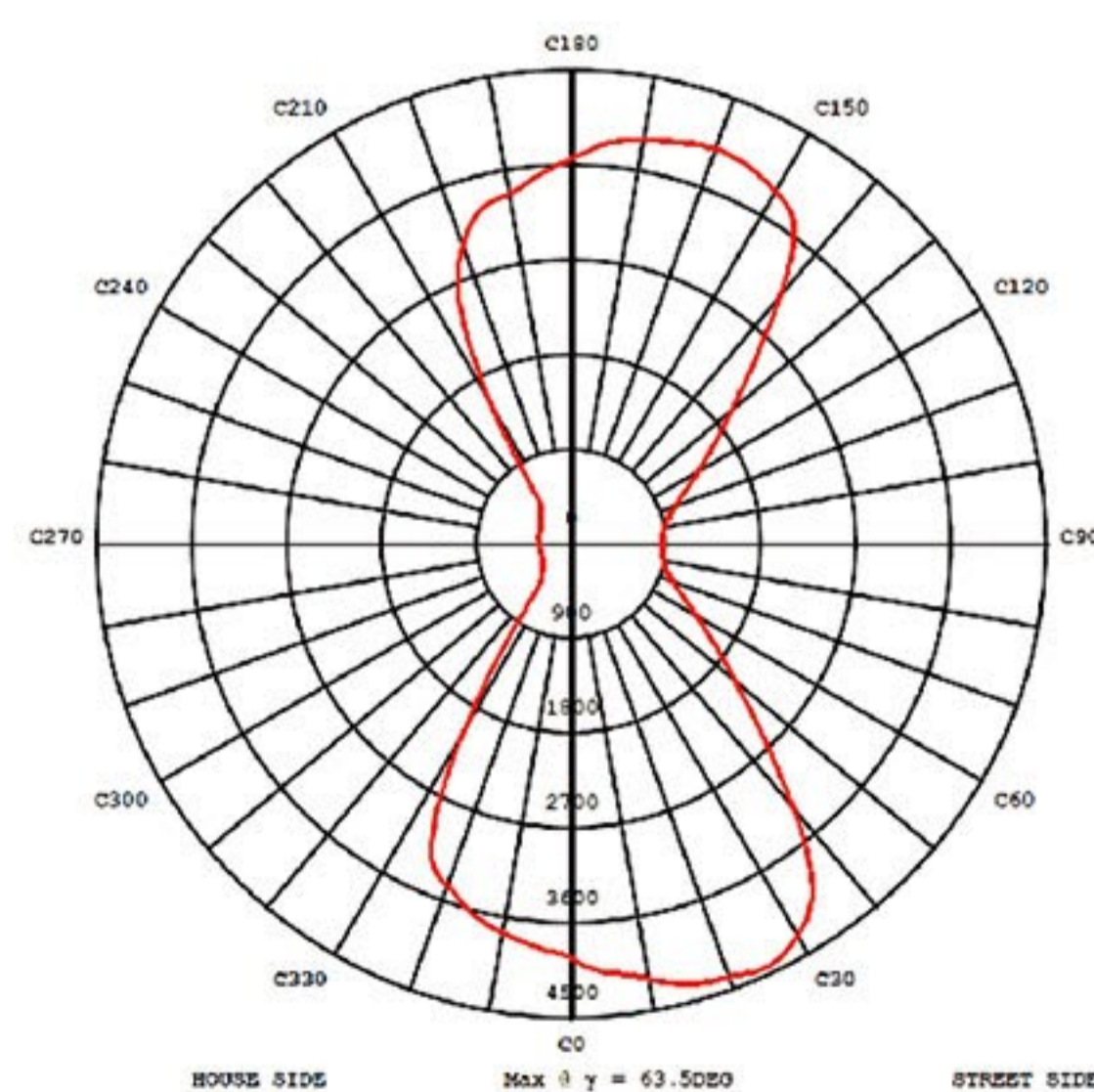
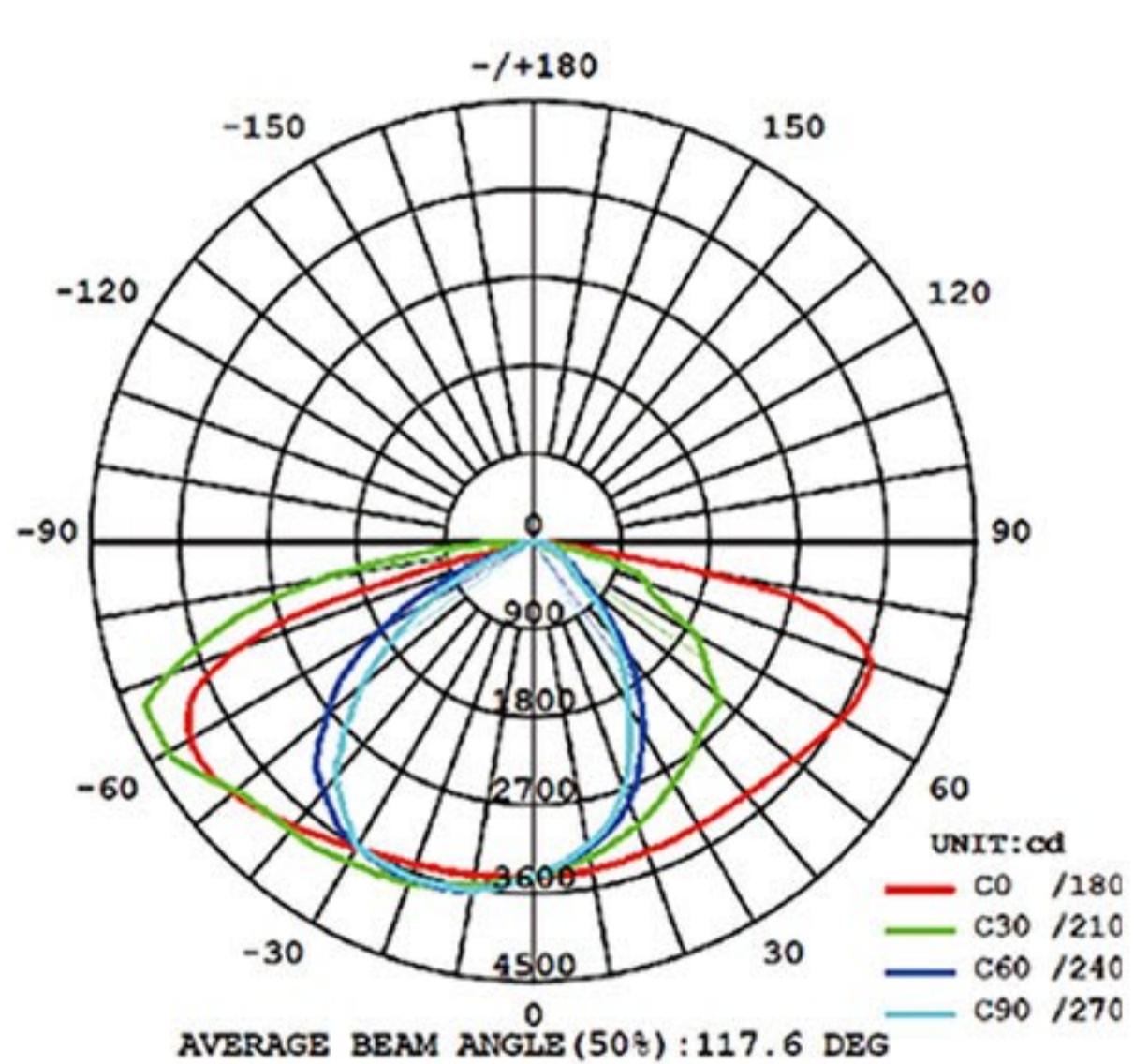

TYPE IV S 153*89°

Product Size

(Unit:mm)

Model	Product Size(L*H*W)	Packing Size(L*H*W)	N.W.	G.W.
BSL30Z-F14X	330*330*90mm	350*350*110mm	2.5kg	2.8kg
BSL40Z-F14X	330*330*90mm	350*350*110mm	2.5kg	2.8kg
BSL50Z-F14X	330*330*90mm	350*350*110mm	2.5kg	2.8kg
BSL60Z-F14X	330*330*90mm	350*350*110mm	2.5kg	2.8kg
BSL70Z-F14X	330*330*90mm	350*350*110mm	2.8kg	3.0kg
BSL80Z-F14X	330*330*90mm	350*350*110mm	2.8kg	3.0kg

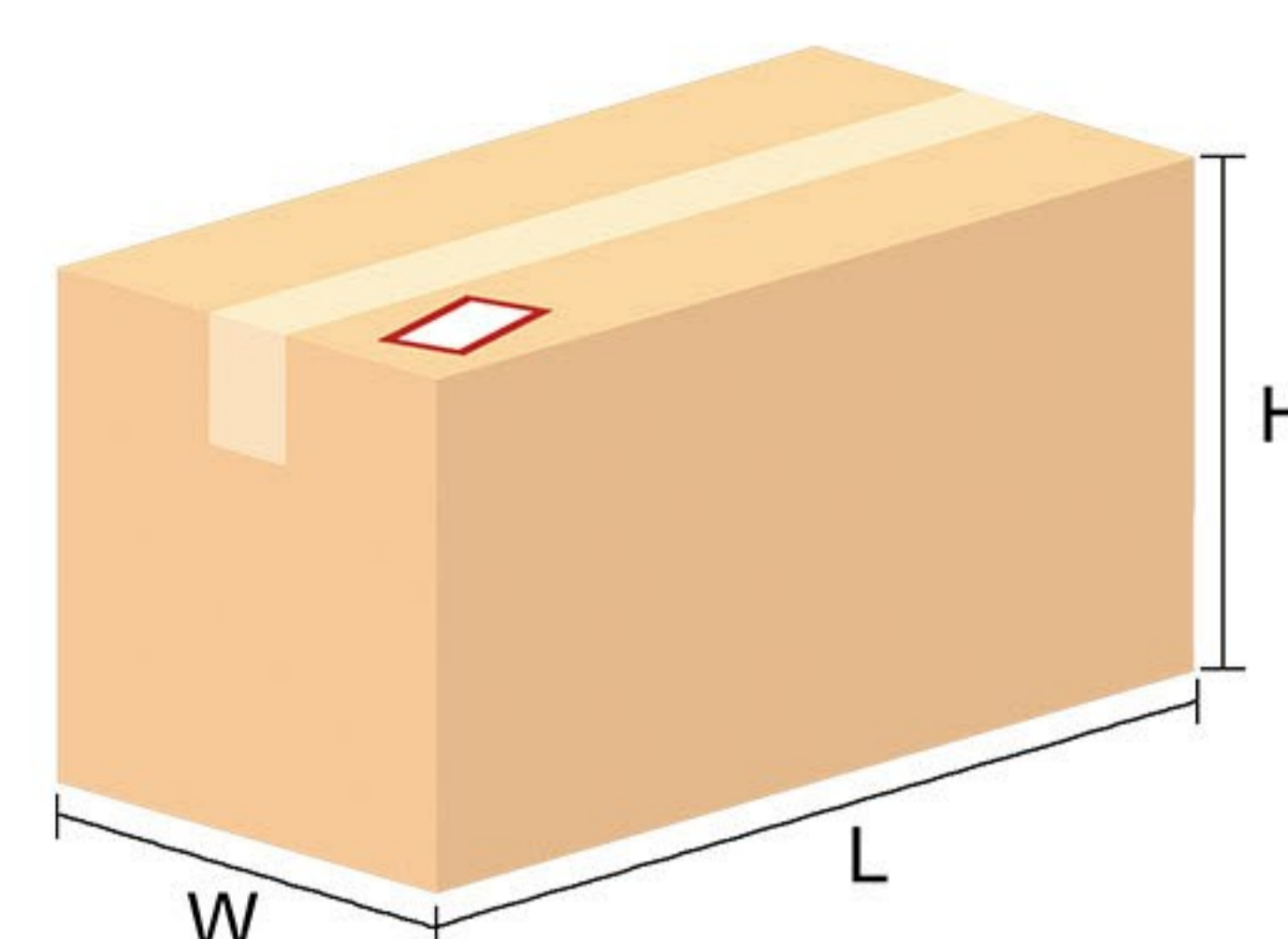
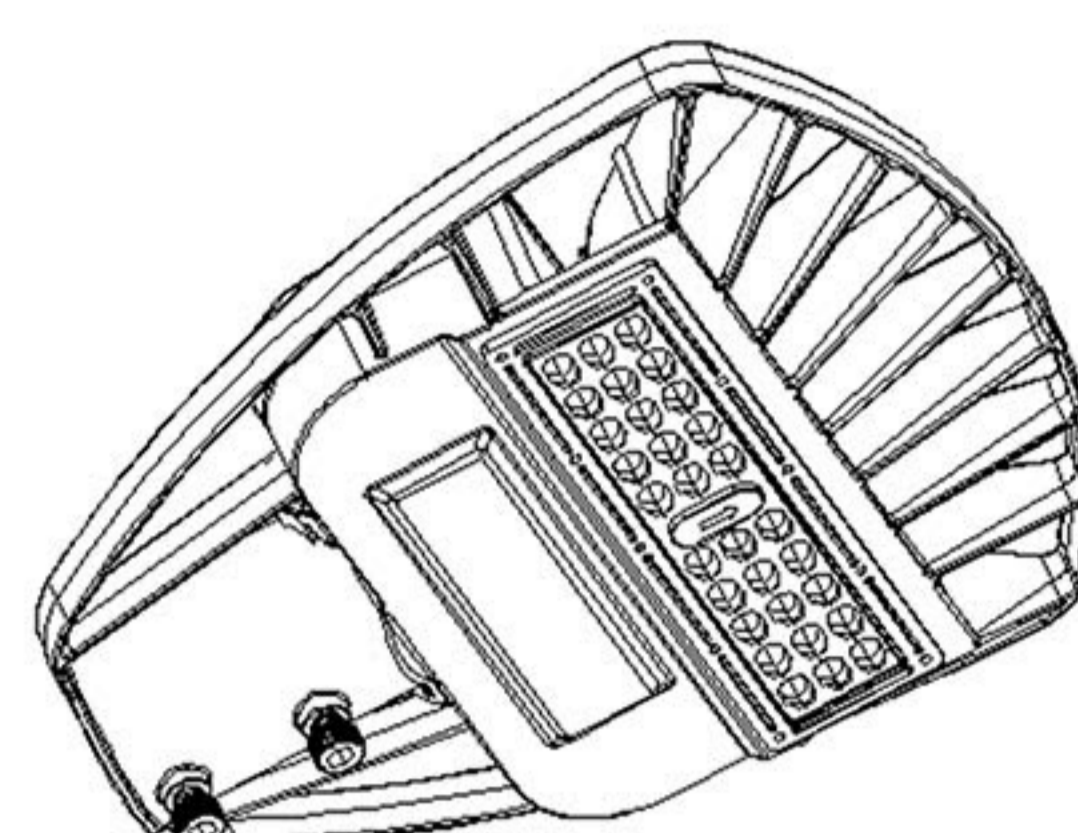
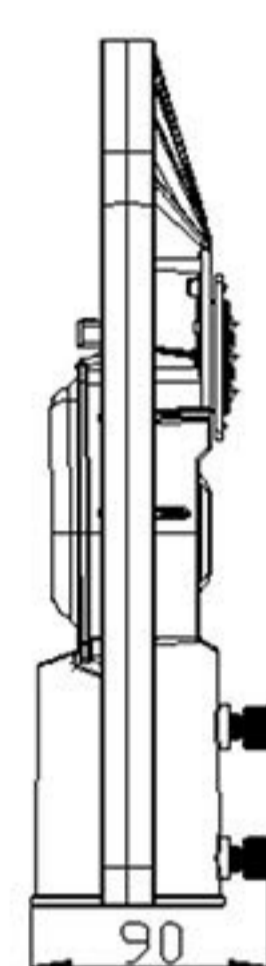
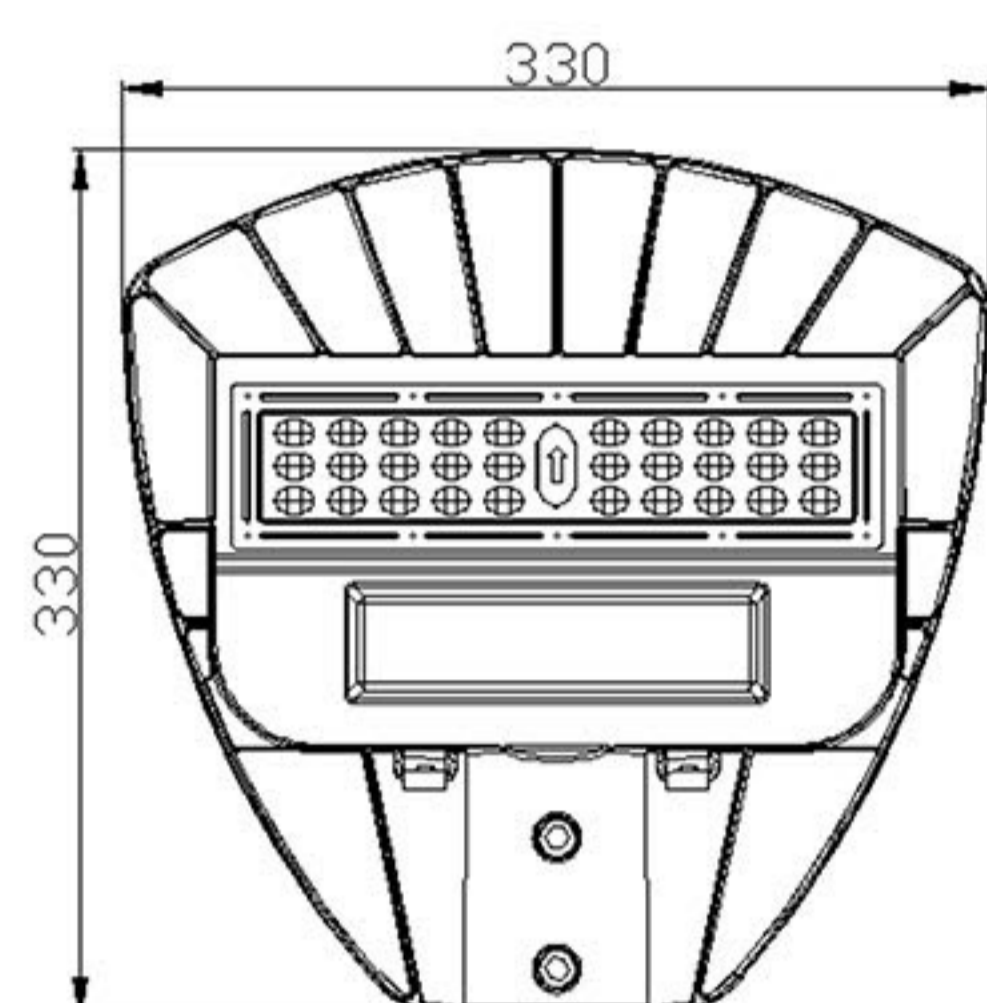

Lamp Distribution Mode

A. Unilateral Mode

B. Bilateral Mode

C. Bilateral-staggered Mode

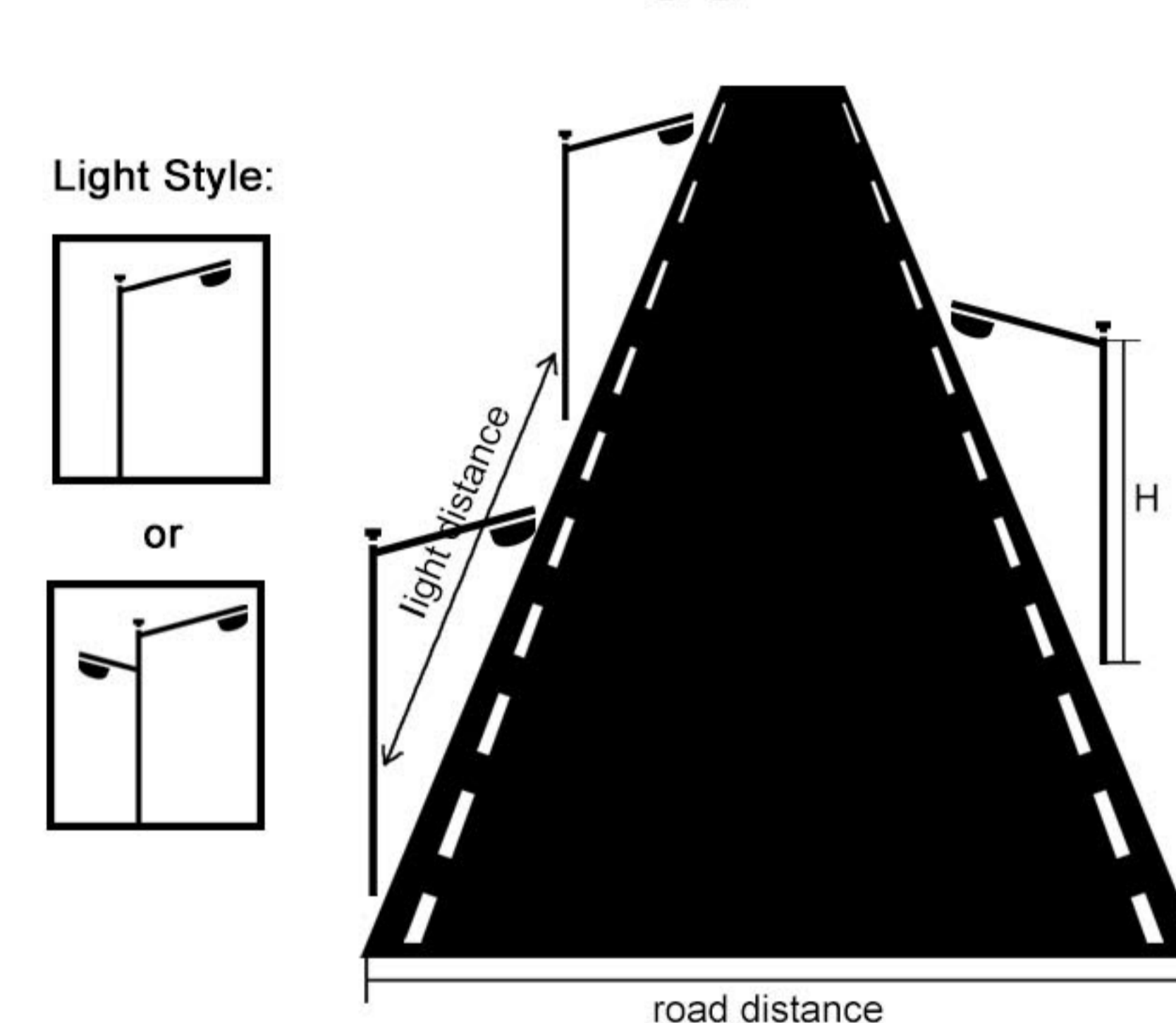
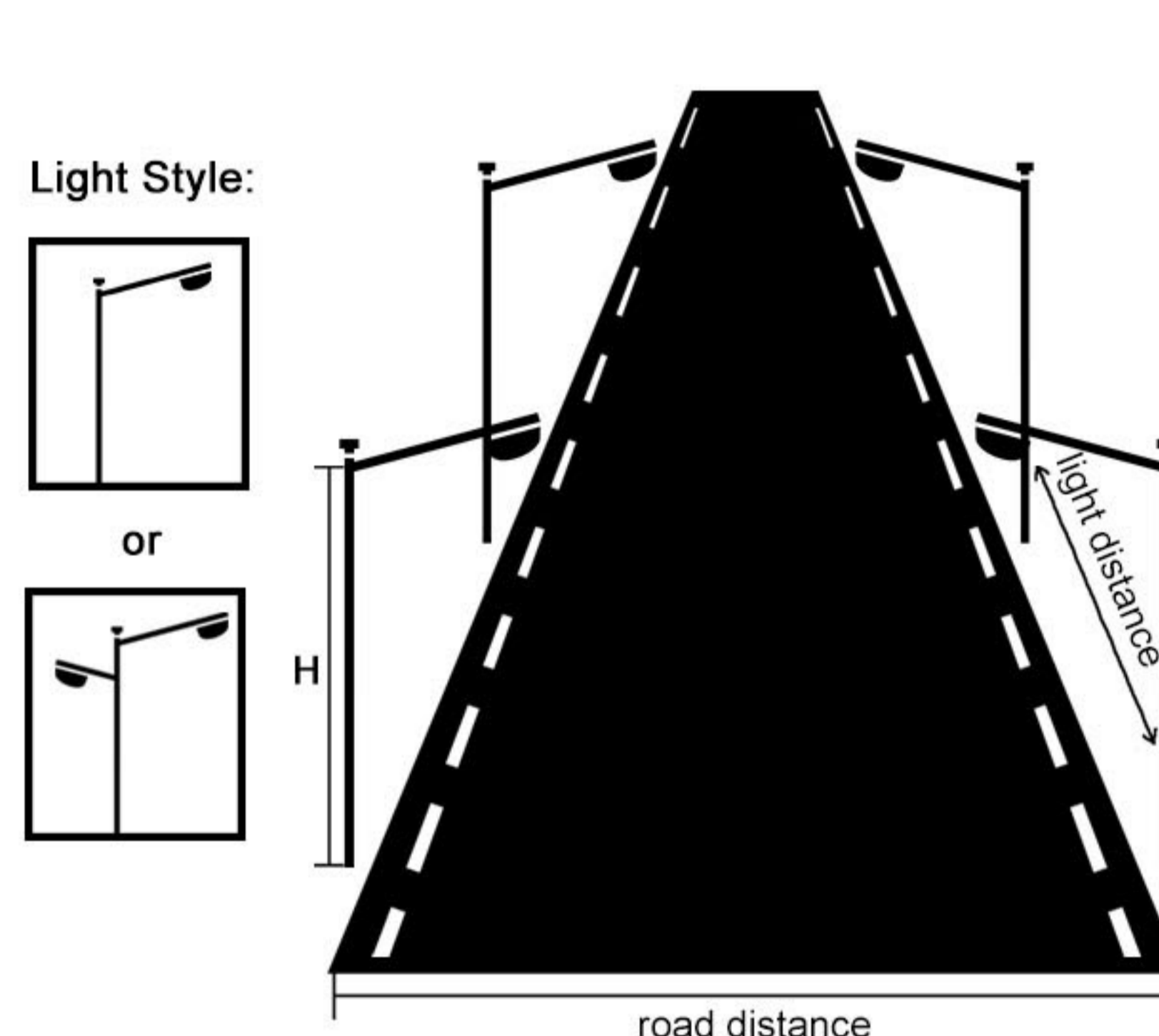
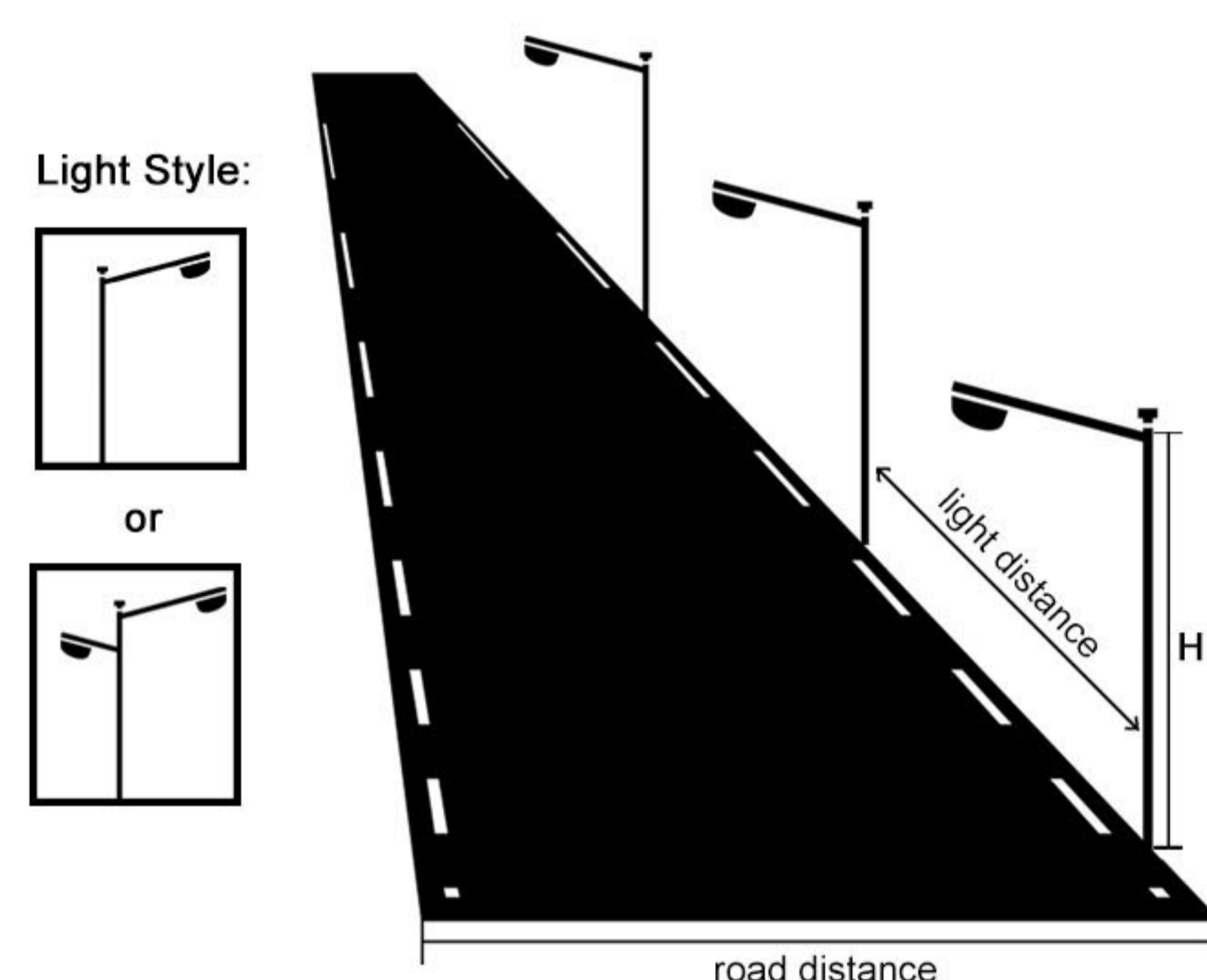

Application Scenes

General lighting for all roadways, avenues, streets etc., area and site lighting for parking lot, playground, sport area etc. Available to replace traditional MH or HPS luminaires up to 150W.

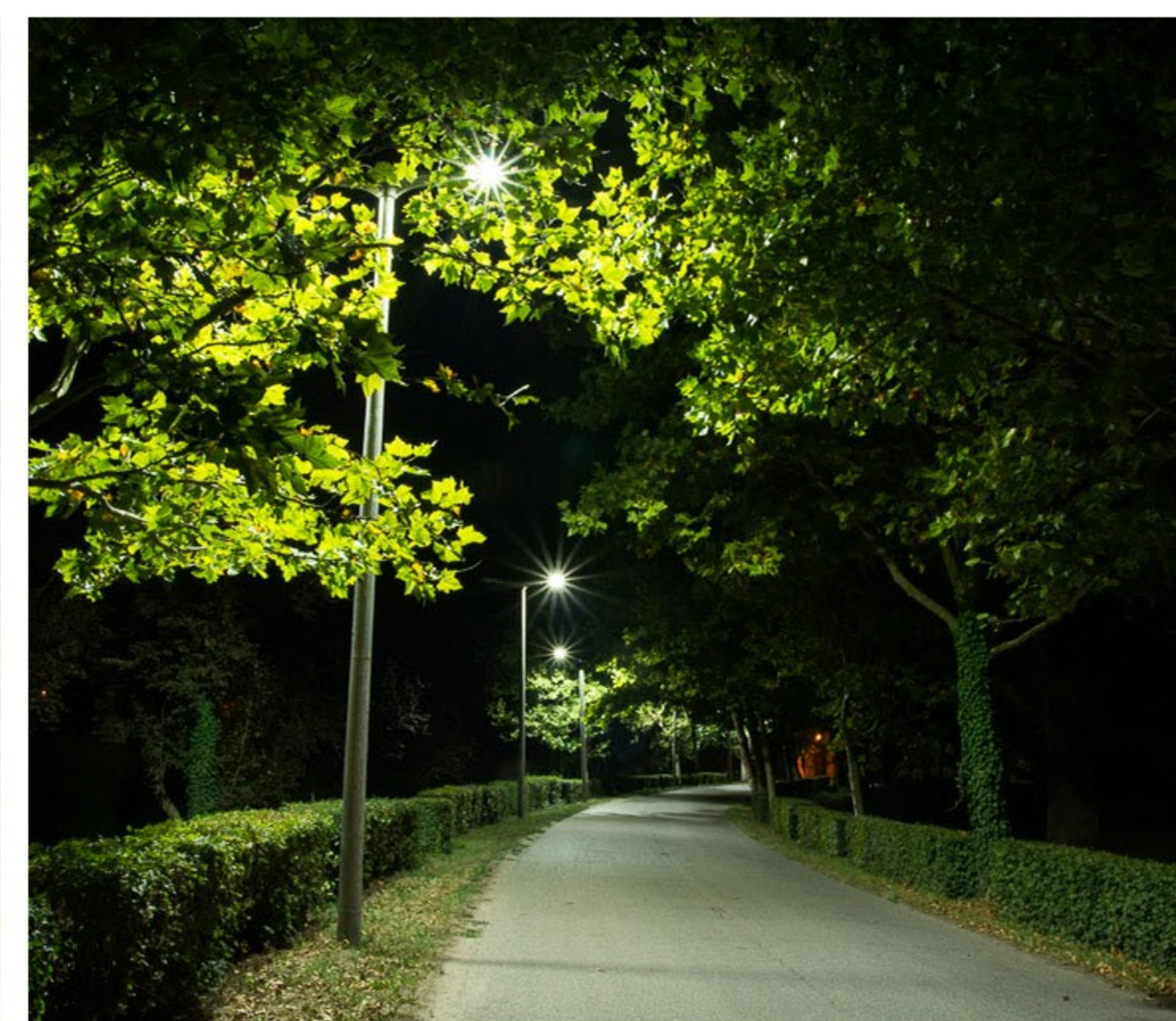
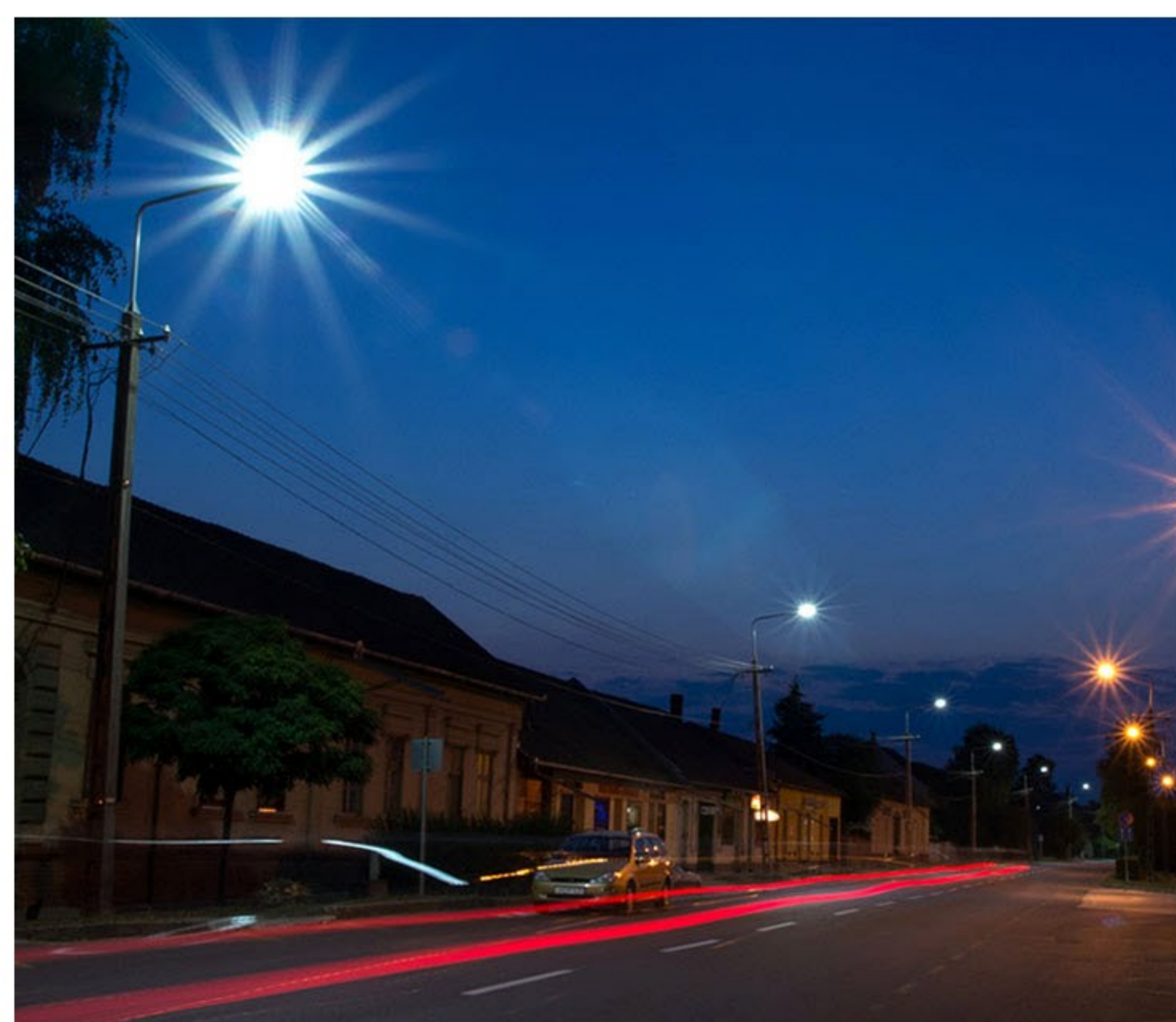

Zhejiang Boshang Optoelectronic Co.,Ltd.

Add:Hezhuang Industrial Zone,Xiaoshan District,Hangzhou City,Zhejiang Province,China.

