

FS SERIES LED STREET LIGHT



CE RoHS CB IP66 IK10 LM-79 TM-21 ISTMT



Patented Design
Private Mould

Function&Features



Technical Parameters

Model No.	BSL030Z-FS	BSL040Z-FS	BSL050Z-FS	BSL060Z-FS	BSL080Z-FS	BSL100Z-FS	BSL120Z-FS	BSL150Z-FS	BSL180Z-FS
Nominal Wattage	30W	40W	50W	60W	80W	100W	120W	150W	180W
Input Voltage	AC100~305V 50~60HZ or DC12/24V (with controller)								
Power Factor	>0.95	>0.95	>0.95	>0.95	>0.95	>0.95	>0.95	>0.95	>0.95
Luminaire Efficacy	>120lm/W(3030 LEDs) / >150lm/W(5050LEDs)								>150lm/W (5050LEDs)
C.R.I	75±5	75±5	75±5	75±5	75±5	75±5	75±5	75±5	75±5
C.C.T	3000K/ 4000K/ 5000K/ 5700K/ 6500K								
Luminaire Material	Die-casting Aluminum + PC								
LED Brand	Lumileds								
Driver Brand	MEANWELL / INVENTRONICS / Other								
Optics	Type I S	Type I S	Type I S	Type I S	Type II S	Type II S	Type II S	Type II M/ Type II S	Type II S
Lifetime	>50,000Hours								
Working Environment	-40℃~50℃ 10%~95% RH								
Warranty	5 Years	5 Years	5 Years	5 Years	5 Years	5 Years	5 Years	5 Years	5 Years

Product Size&Packing Data

Model No.	Product Size(L*H*W)	Packing Size(L*H*W)	N.W.	G.W.
BSL030Z-FS	380*170*120mm	420*190*170mm	2.3kg	2.8kg
BSL040Z-FS	380*170*120mm	420*190*170mm	2.3kg	2.8kg
BSL050Z-FS	380*170*120mm	420*190*170mm	2.3kg	2.8kg
BSL060Z-FS	380*170*120mm	420*190*170mm	2.3kg	2.8kg
BSL080Z-FS	470*230*123mm	520*250*180mm	3.4kg	4.2kg
BSL100Z-FS	470*230*123mm	520*250*180mm	3.6kg	4.4kg
BSL120Z-FS	470*230*123mm	520*250*180mm	3.9kg	4.7kg
BSL150Z-FS	550*270*125mm	590*290*180mm	4.7kg	5.7kg
BSL180Z-FS	550*270*125mm	590*290*180mm	5.0kg	6.0kg

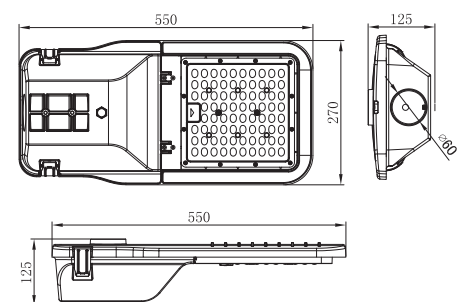
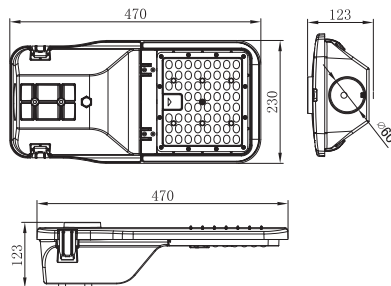
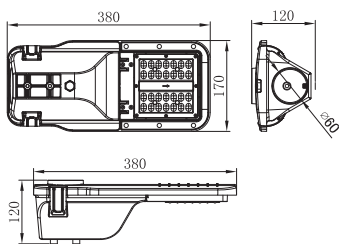

BSL030Z-FS / BSL040Z-FS
BSL050Z-FS / BSL060Z-FS

BSL080Z-FS / BSL100Z-FS / BSL120Z-FS

BSL150Z-FS / BSL180Z-FS

Lamp Distribution Mode

A.Unilateral Mode

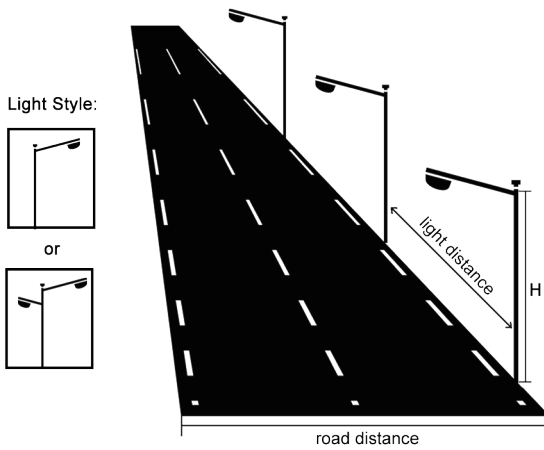

B.Bilateral Mode

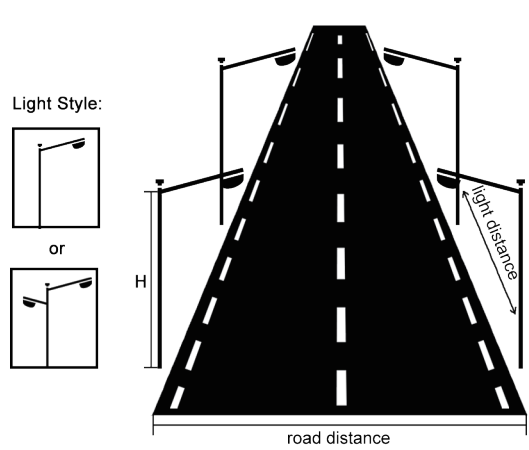

C.Bilateral-staggered Mode

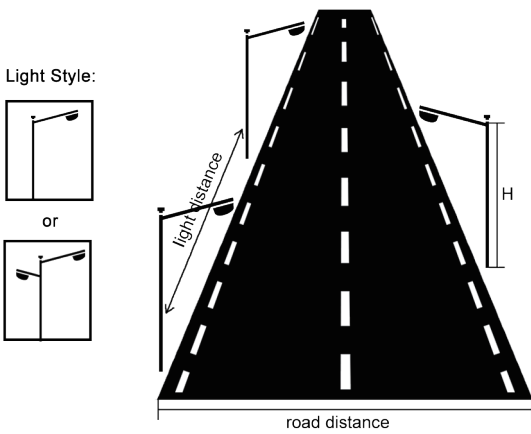

D.Central Symmetric Mode

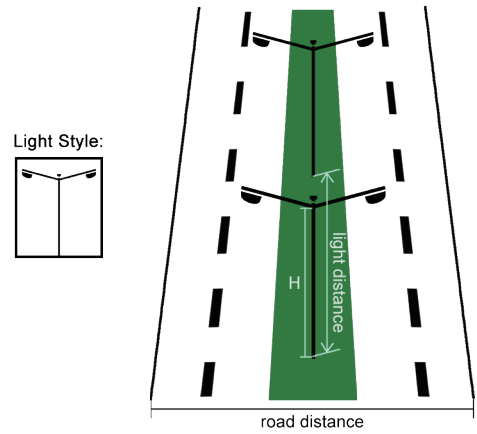

Application Scenes

General lighting for all roadways, avenues, streets etc., area and site lighting for parking lot, playground, sport area etc. Available to replace traditional MH or HPS luminaires up to 400W.



Zhejiang Boshang Optoelectronic Co.,Ltd.

Add:Hezhuang Industrial Zone,Xiaoshan District,Hangzhou City,Zhejiang Province,China.

